

2900F1

OPERATING INSTRUCTIONS

Model 2900F1 "QUICK DRAW" SOILMOISTURE PROBE

October 2009



(Figure 1) - 2900F1 Soilmoisture "Quick Draw" Probe

The 2900F1 QuickDraw Soilmoisture Probe is the most effective portable moisture measuring instrument available. Designed for rugged field use, the patented thermos construction utilizing capillary tube connections and super porous ceramic tip assures fast response and accurate readings, independent of temperature differences. The self-servicing feature, unique in tensiometer construction, eliminates the need for accessory service kits, and assures fast response times after years of use.

The Probe is shipped in a dry condition for greater convenience in handling and storage over a period of time. Follow the simple instructions to water fill your unit in preparation for use.

SOILMOISTURE EQUIPMENT CORP.
P.O. Box 30025, Santa Barbara, CA 93105 U.S.A.
Telephone 805-964-3525 - Fax No. 805-683-2189
www.soilmoisture.com - sales@soilmoisture.com



TABLE OF CONTENTS

| | |
|--|---------|
| Table of Contents..... | Page 2 |
| Unpacking..... | Page 3 |
| Cautions & Warnings..... | Page 3 |
| Warranty & Liability..... | Page 3 |
| Aquaint Yourself With The Parts..... | Page 4 |
| Theory of Operation..... | Page 5 |
| Venting and Adjusting Dial Gauge..... | Page 6 |
| Requirements Prior to Use / Initial Filling..... | Page 7 |
| Installation..... | Page 11 |
| Making a Soil Moisture Measurement..... | Page 11 |
| Dial Gauge Pressure Build-up..... | Page 14 |
| Irrigation Scheduling..... | Page 15 |
| Routine Measurements..... | Page 16 |
| Troubleshooting..... | Page 17 |
| Replacing the Ceramic Tip..... | Page 18 |
| Replacing the Dial Gauge..... | Page 20 |
| Time Required to make a Reading..... | Page 22 |
| Tips for Scheduling Irrigations..... | Page 23 |
| Care and Maintenance..... | Page 24 |
| Parts List..... | Page 26 |

UNPACKING

Not Liabie for improper use. Remove all packing materials and check the 2900F1 Soilmoisture "Quick Draw" Probe for any damage that may have occurred during shipment. If the Sampler is damaged, call the carrier immediately to report it. Keep the shipping container and all evidence to support your claim.

Do not bump or drop the dial gauge or ceramic sensing tip or they could break and will need to be replaced. Take care not to let the sensing tip come in contact with grease or any other similar material that could clog the pores of the ceramic.

Please verify that your shipment is complete.

CAUTIONS & WARNINGS

The Soilmoisture "Quick Draw" Probe should be removed from the field prior to the onset of freezing conditions. Since the Probe is a water-filled system, it is essential that the unit be stored and used at temperatures above freezing. Freezing temperatures, of course, will cause the water within the unit to freeze and expand as ice is formed. This can cause breakage of the ceramic tip and distort or rupture the thin-walled Bourdon tube within the dial gauge.

If the Bourdon tube is ruptured, the dial gauge cannot be repaired and will have to be replaced. If the Bourdon tube is distorted but not ruptured, it may be possible to reset the pointer on the gauge to correct the change in calibration caused by freezing.

Intense heat can cause the plastic Carrying Case to distort and can result in the evaporation of all water from the sponge within the Carrying Case. This will be detrimental to the operation of the Soilmoisture Probe. It will also result in frequent servicing for removal of air. Do not subject the Soilmoisture Probe to intense heat while storing or transporting it. Very high temperatures can develop within a closed cab of a truck or the trunk of a car.

Please see page for care and user tips.

WARRANTY & LIABILITY

Soilmoisture Equipment Corp. (SEC) warrants all products manufactured by SEC to be free from defects in materials and workmanship under normal use and service for twelve (12) months from the date of invoice provided the section below has been met.

Soilmoisture Equipment Corp. (SEC) is not liable for any damages, actual or inferred, caused by misuse or improper handling of its products. SEC products are designed to be used solely as described in these product operating instructions by a prudent individual under normal operating conditions in applications intended for use by this product.

AQUAINT YOURSELF WITH THE PARTS

CARRYING CASE



PROBE

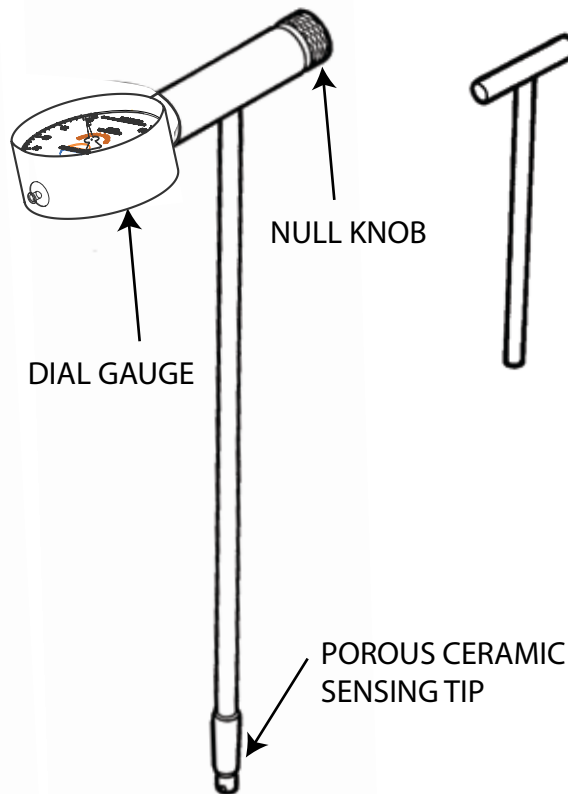

CORING TOOL

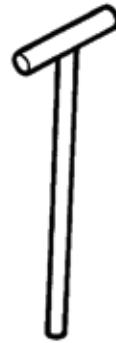

CLEANING ROD

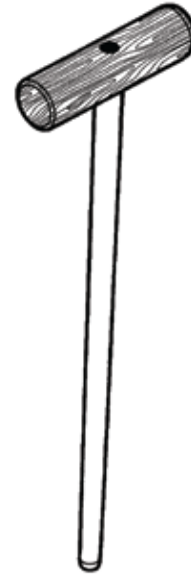

DIAL GAUGE

NULL KNOB

POROUS CERAMIC SENSING TIP

(Figure 2) - 2900K1 Parts

The Probe, Coring Tool, and Cleaning Rod are held in place by the molded plastic retainers at the top of the Carrying Case.

NOTE: The Probe fits into the side of the Carrying Case that is marked "PROBE", and the Coring Tool fits into the other side of the Carrying Case that is marked "CORING TOOL". (Fig. 3).

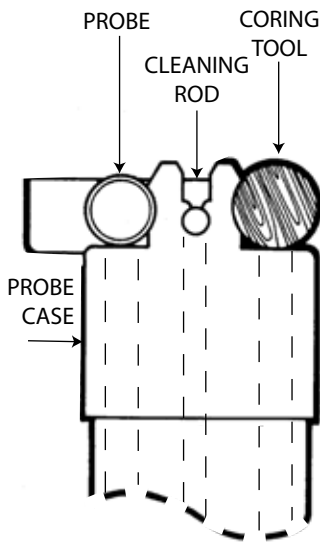

(Figure 3) - Probe case Tool placement

It is very important to keep the Probe in the side of the Carrying Case marked "PROBE" when it is not actually being inserted in the soil, because this side of the Carrying Case has a water storage reservoir at the bottom. During the "Initial Filling" operation, pictured and described on pages 7 through 10, you will fill the water storage reservoir. Thereafter, the sensing tip of the Probe will be kept moist.

An Accessory Kit is provided with each Probe. It consists of a small screwdriver, a 3/32" Allen wrench, and a replacement sensing tip and seals. The screwdriver is used to vent and adjust the dial gauge and to replace the sensing tip. The Allen wrench is used in the event the dial gauge needs replacement.

THEORY OF OPERATION

The Model 2900F Soilmoisture Probe is a tensiometer-type instrument that reads soil suction directly. The "soil suction" reading is a direct measure of the availability of moisture for plant growth, and the standard unit of measurement is the "bar". The bar* is a unit of pressure in the metric system and is used to define positive pressure (above atmospheric pressure), or negative pressure or vacuum (below atmospheric pressure).

The gauge on the Probe is calibrated in hundredths of a bar (or centibars) of vacuum, and is graduated from zero to 100.

In scientific work, it is becoming customary to express pressures and vacu-ums in a unit of measure called a "Pascal", and a "Kilopascal", which is 1000 times as large as a Pascal. A "centibar", as used above, is exactly equal to a Kilopascal. Therefore, the dial gauge on the Probe also reads in kilopascals and is graduated from zero to 100 kilopascals (KPa).

Soil suction is actually created by the attraction that each soil particle has for the water in the soil. Because of this attraction, water forms a film around each particle of soil and collects in the capillary spaces between the soil particles. As the soil becomes drier, these films become thinner and the attraction or soil suction increases. The plant root has to over-come this soil suction, or attraction force, in order to withdraw moisture from the soil. The measurement of soil suction then gives a direct indication of the amount of work the plant root must do to get water from the soil. The only moisture measuring instruments that accurately measure soil suction are those using the tensiometer principle. These instruments read centibars of soil suction directly without calibration for soil type, salinity, or temperature.

When the Probe is inserted into the cored hole, there are various effects associated with the movement of the porous ceramic sensing tip through the soil. The soil surrounding the tip is slightly compacted and the wiping action of the porous ceramic through the soil causes small thermal effects. It takes a few moments for these disturbances to disperse, and this is the reason that it is not desirable to move the Null Knob for the first minute after insertion of the Probe.

In order to obtain a soil suction reading, it is necessary for a small amount of water to transfer between the sensing tip of the Probe and the soil. When the Null Knob is turned clockwise, water is forced out of the Probe sensing tip and into the surrounding soil. When the Null Knob is turned counterclockwise, a vacuum is created within the Probe, which causes moisture to move from the soil through the ceramic sensing tip and into the Probe. In order to obtain an accurate reading within the minimum amount of time, one must be careful not to disturb the moisture conditions surrounding the sensing tip.

Steps for initial filling (before installation)

When examining the Probe, DO NOT leave the porous ceramic sensing tip exposed to the air for prolonged periods. When the Probe is removed from the Carrying Case and the sensing tip is not kept moist, evaporation of moisture from the tip will pull the dial gauge up to a very high centibar reading. Under these conditions, air can diffuse through the water in the pores of the sensing tip and enter the Probe, which can result in a decrease in sensitivity and require a refilling cycle.

Venting and Adjusting the Dial Gauge

The 2060FG dial gauge is hermetically sealed at the factory at sea level. If you live at a higher elevation, the pointer on the dial gauge may read higher than zero when you unpack it. This is due to the lower atmospheric pressure at your elevation.

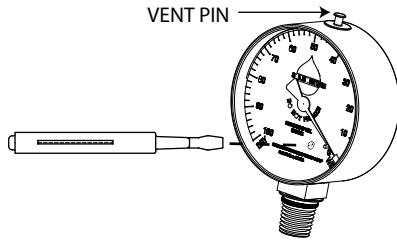

(Figure 4) - Venting the gauge

First, simply press the vent pin located, at the top of the gauge, to release any collected air. Located on the face of the gauge is an insertion point for a small flathead screwdriver. If the gauge is reading high, turn the screwdriver clockwise an estimated amount to correct the error. If the gauge reads low, turn the screwdriver counterclockwise an estimated amount to correct the error. Repeat the process if necessary until the pointer is on zero.

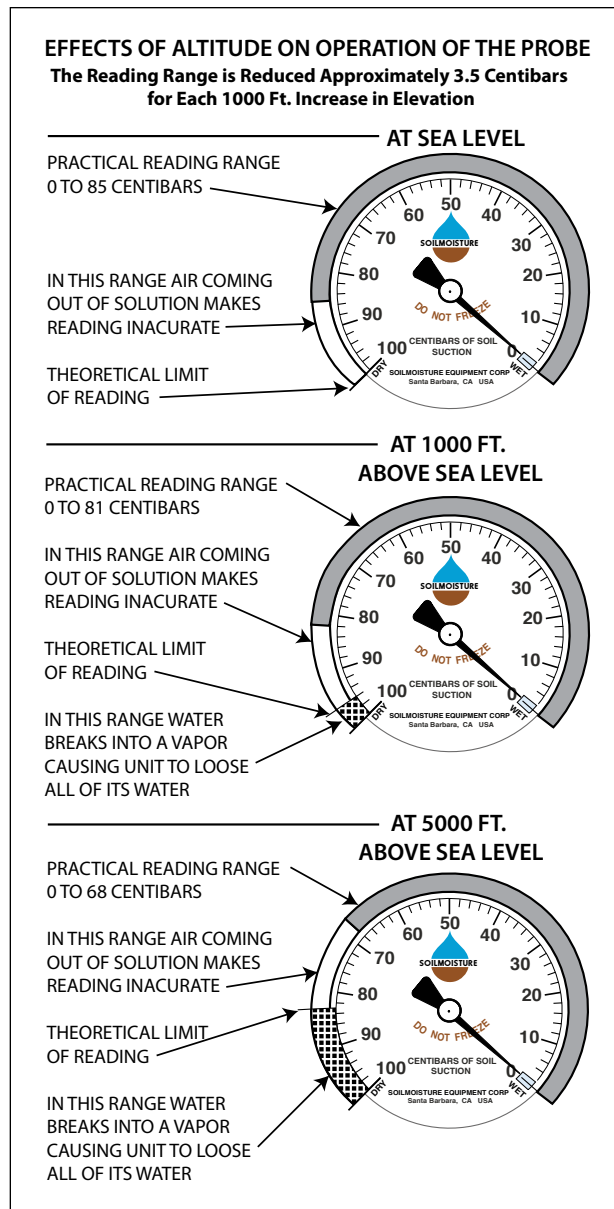

(Figure 5) - Effects of Altitude

REQUIREMENTS PRIOR TO USE / INITIAL FILLING

STEP 1

Turn Null Knob clockwise as far as it will go and then insert the porous ceramic sensing tip in water.



(Figure 6)

STEP 2

Keep the sensing tip in water. Turn the Null Knob counterclockwise until you just see the red ring.

On initial filling, the pointer will normally rise to a reading of 40 to 50. Let the pointer drop to zero.



(Figure 7)

STEP 3

Keep the sensing tip in water. Continue to turn the Null Knob slowly counterclockwise until it is loose and can be removed.



(Figure 8)

REQUIREMENTS PRIOR TO USE / INITIAL FILLING (cont.)



(Figure 9)

STEP 4

Fill the handle with water. A teaspoon works well for this operation. Water should be poured into the handle slowly and carefully so that air bubbles are not trapped. If you see a bubble clinging to the smooth wall or bottom of the handle cavity, nudge it free with the sharp end of a pencil.



(Figure 10)

STEP 5

Screw the Null Knob completely back in the Handle, which will push out excess water.

While you are doing this, water will ooze out through the porous ceramic tip and drip off the end.



(Figure 11)

STEP 6

Turn the Null Knob clockwise as far as it will go.

REQUIREMENTS PRIOR TO USE / INITIAL FILLING (cont.)



(Figure 12)

STEP 7

Remove the tip from the water and dry it with Kleenex or similar absorbent tissue. The dial pointer will rise to a reading of 20 or 30 as moisture is pulled into the dry tissue.



(Figure 13)

STEP 8

Turn the Null Knob counterclockwise until you just see the red ring. The pointer will normally rise to a reading of 80 or 90 centibars if you live at an elevation between sea level and about 2000 ft. If you live at higher elevations, the maximum reading will be somewhat lower. See page 14, which describes the effect of altitude on the operation of the Probe.

If the pointer does not rise it can mean that rough handling has cracked the porous ceramic sensing tip. See section on "Care and Maintenance" for corrective action.



(Figure 14)

STEP 9

Immerse the porous sensing tip again in water and wait until the pointer drops to zero.

REQUIREMENTS PRIOR TO USE / INITIAL FILLING (cont.)

STEP 10

Repeat Step 3, removing the Null Knob again while the sensing tip is in the water. Repeat Steps 4, 5, and 6, again refilling the handle with water. Insert the Null Knob and turn it clockwise as far as it will go.

STEP 11

Check Response Time. To do this, wipe the Probe and porous ceramic tip with absorbent tissue to remove all excess water. Turn the Null Knob until the pointer reaches a reading of 50 on the dial. Now when you dip the sensing tip in the water, the pointer will normally drop from a reading of 50 to 10 in approximately one second - the time that it takes to say "one, one thousand". The Probe is ready for use if the response time is approximately one second.



STEP 12

Fill the Carrying Case tube, which is labeled "PROBE" with water and allow it to stand for a minute or two (See Fig.15). This will fill the sponge cartridge with water. Empty out excess water and insert the Probe. The sponge cartridge in the Carrying Case will now keep the porous ceramic sensing tip wet so it is ready to use at any time in the field. In the future, always keep the Probe in the Carrying Case when not in use.

(Figure 15)

Response time is too long

After initial filling, if the response time is considerably more than one second, it usually indicates that an air bubble has been trapped in the handle. To correct this, simply repeat Steps 8 and 9, then Steps 3, 4, 5, and 6. Again look into the handle cavity after filling to see if there are any bubbles clinging to the internal wall. In the event there are bubbles, simply nudge them loose with the sharp end of a pencil. Fill the cavity in the handle to the top, replace the Null Knob, wipe it dry, and again check the response time.

About the Dial Gauge and Carrying Case

The pointer may have to be adjusted after the filling operation. First read the following section concerning the Dial Gauge and then refer to the "Venting and Adjusting the Dial Gauge" section for specific instructions for adjusting the dial gauge pointer.

When the Probe is in the Carrying Case and is held vertically, the pointer on the dial gauge should read zero. You will note, however, that if the Carrying Case is tipped horizontally, the pointer on the dial gauge will read below zero. This is caused by the shift in weight of the water column within the Probe. For normal use, the dial pointer is set at zero when the Probe is held vertically and only when the ceramic sensing tip is immersed in water. For pointer setting instructions, see the "Care & Maintenance" section.

INSTALLATION / MAKING A SOIL MOISTURE MEASUREMENT

STEP 1 - CORING A HOLE

The first operation in taking a reading is to core a hole to accept the Probe using the Coring Tool. The Coring Tool is pushed vertically into the soil (Fig. 16). After reaching the depth desired, the Coring Tool is removed.



(Figure 16)

This operation will pull out the soil core and provide a proper sized hole for insertion of the Probe.

The soil should be cleaned from the coring tool after each coring operation to make sure that the succeeding core will be properly cut. Remove the core by inverting the coring tool so the core can slip out of the handle end. The core itself gives a good profile of the soil below the surface. The Cleaning Rod can be used to remove any remaining soil from the cutting tip, as shown in Fig. 17. In the event the soil becomes lodged inside the Coring Tool, strike the side of the steel Coring Tool with the side of the Cleaning Rod to jar the soil inside loose.

If an impediment is encountered, such as a rock or hard root, when coring the hole simply move to an adjacent location and core another hole. After the reading has been made, no attempt should be made to plug the hole, since the small hole is not detrimental and will provide desirable aeration.



(Figure 17)

The Coring Tool makes a hole in the soil, which is tapered at the bottom. The larger portion of the hole provides clearance for the Probe when it is inserted into the hole until it reaches the proper depth for measurement. When the sensing tip of the Probe reaches the bottom of the hole, push it firmly into the tapered portion of the hole so a tight contact is made between the sensing tip and the soil. This tight contact is essential to make a good, fast soil suction measurement (see Fig. 18).

The Coring Tool is made from strong, chromemoly steel, and will withstand considerable punishment. If the soil surface is too hard or dry for the Coring Tool to penetrate, the surface soil can be broken with a larger soil sampling tool or shovel. The Coring Tool can then be pushed into the hole created to provide a properly sized hole to accept the Probe.

In loose, cultivated soils and planting mixes, the Probe can frequently be pushed directly into the soil without coring a hole. When taking measurements in these loose soils make sure the porous ceramic sensing tip is in good contact with the soil and the Probe is inserted without using undue force.

MAKING A SOIL MOISTURE MEASUREMENT (cont.)

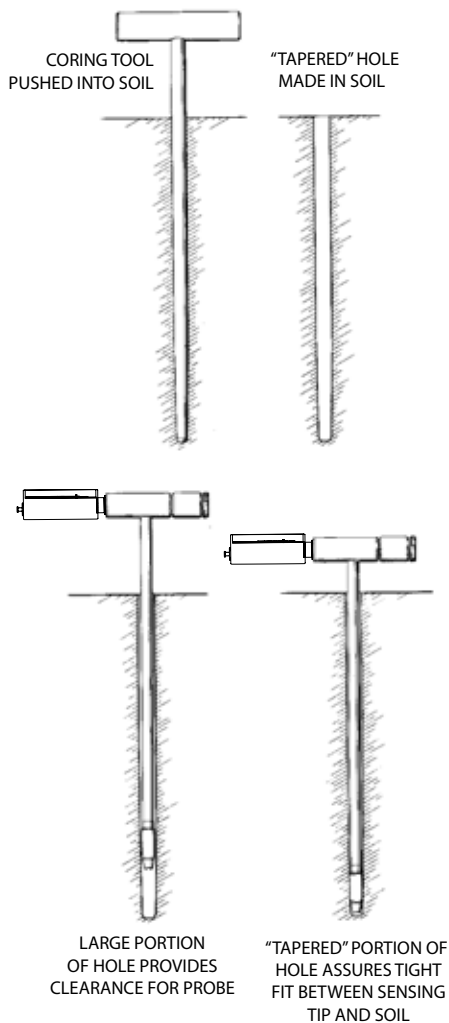

(Figure 18)

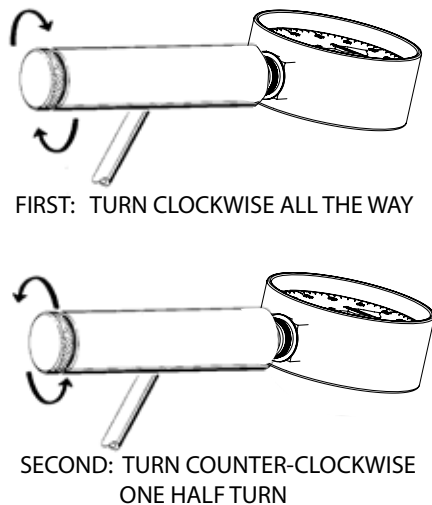

(Figure 19)

STEP 2 - INSERTING THE PROBE

Prior to removing the Probe from the Carrying Case, turn the Null Knob clockwise as far as it will go and then undo the knob (counterclockwise) approximately 1/2 turn. This operation will provide the proper range for the Null Knob when taking a reading (see Fig. 19).

Next, remove the Probe from the Carrying Case and insert it into the hole made by the Coring Tool. Push it in so the sensing tip is in firm contact with the soil. (see Fig.20).

NOTE: If the Probe has been stored in a very hot environment such as the back of a truck, you should leave the Probe in the initially cored hole for two to three minutes to bring the Probe to approximate temperature equilibrium with the soil. The Model 2900F Probe has been designed to have very minimum temperature effects. However, it is desirable to eliminate extreme temperature variations between the soil and the Probe in order to obtain the fastest response and ease of use. After the initial temperature adjustment, when necessary return the Probe to the Carrying Case to drop the pointer reading to zero. Then core an adjacent hole and re-insert the Probe.

If the soil is saturated with water, the pointer of the dial gauge will remain at zero. Otherwise, the pointer will immediately start to rise when the Probe is inserted into the hole. After insertion, allow the Probe to remain undisturbed for approximately one minute. At the end of one minute, observe the pointer reading.

MAKING A SOIL MOISTURE MEASUREMENT (cont.)

Turn the Null Knob counterclockwise to bring the pointer up to a value, which is one and one-half times the initial reading after the one-minute period. In other words, if the reading after one minute is 20 centibars, turn the Probe so the reading is adjusted to 30 centibars. If the reading is 40 centibars, turn the Null Knob so the pointer is at 60 centibars, etc.

After making the first adjustment, observe the pointer movement after 15 to 30 seconds. Tapping the dial gauge lightly with your finger while observing the pointer movement will tend to reduce the normal internal friction so changes in the pointer position can be observed with minimum lapsed time. If the pointer is moving down to a lower value than the one set, you know that the correct soil suction value is somewhere between the initial reading at one minute and the adjusted value. In this case, turn the Null Knob in a clockwise direction to lower the pointer to read half way between the initial value and the first set value. After this second adjustment, again observe the direction in which the pointer is moving and then make a sub-sequent adjustment to an intermediate value. This process “brackets” the actual soil suction value, and you can very quickly adjust the Probe to the true soil suction value. When the pointer is adjusted to the true soil suction value, it will not move up or down, but will remain in a fixed position.



(Figure 20)

If, after the first adjustment, the pointer continues to move up to a higher rather than a lower reading, you should immediately move the pointer approximately 10 centibars higher and observe the pointer movement. If it continues to move up to a higher value, advance the pointer an additional 10 centibars. Once you reach a level where the pointer starts to move back down, you have “bracketed” the reading, and adjustments can be made, as described above, to arrive at the correct value.

In many moist soils, the Probe will come to equilibrium very quickly without any appreciable adjustment of the Null Knob.

Through experience in using the Probe in your soils, you will soon be able to estimate the final dial gauge reading by the speed the pointer moves after insertion of the Probe. It is best to minimize the use of the Null Knob to limit disturbing the soil moisture conditions being measured.

After making a reading, the Soilmoisture Probe should be wiped free of surplus clinging soil and immediately returned to the Carrying Case so the sensing tip remains moist by being in contact with the water storage sponge, with the dial gauge reading zero. When making field measurements, if the soil suction value exceeds the highest operating value corresponding to your elevation, the Probe should not be left in the soil for extended periods.

Soil moisture values can vary considerably within a given area because of differences in root action, drainage and exposure. For this reason, it is desirable to make several readings in a given area in order to fully evaluate the soil moisture conditions.

MAKING A SOIL MOISTURE MEASUREMENT (cont.)

It has been our experience that accurate, reliable moisture readings can be made within a few minutes at any one given location. In general, the readings can be made more quickly when soil suction levels are in the low range than when they are in the high range.

No problems in measurement will be encountered in sandy or sandy-loam soils. In the event you are making measurements in extremely heavy clay soils, more time than normal will be required to reach equilibrium because of the extremely slow movement of water through this type of soil.

DIAL GAUGE PRESSURE BUILD-UP CAUTION!

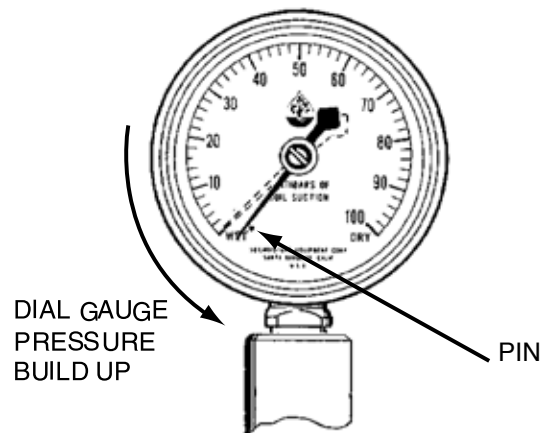

(Figure 21)

CAUTION

In wet clay soils, the plastic soil itself can make an airtight closure around the sensing tip as the Probe is being pushed into the soil. If this happens, pressure can be built up in the Probe by the air trapped in front of the Probe, see Fig. 39. Since this air is sealed by the wet clay soil, a high air pressure can develop as the Probe is pushed further and further into the soil.

To detect such a condition, observe the dial pointer when pushing the Probe down into the soil. If the pointer moves below the zero mark and touches the pin, pressure is building up. See Fig. 40. Stop pushing and pull the Probe up to relieve the pressure. Then push the Probe down and pull up again in short strokes to enlarge the hole in the sensing tip area, which will prevent the entrapment of air. Then push the Probe to full depth and make a reading.

GAUGE READINGS / IRRIGATION SCHEDULING

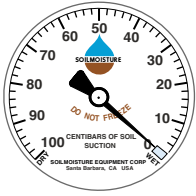

ZERO:

A gauge reading of zero means the surrounding soil is completely saturated with water, regardless of the type of soil. Zero readings can be expected after a heavy rain or deep irrigation. If the zero reading persists after a long period of time, there will be oxygen starvation to plant roots and development of diseases. A persistent zero reading after irrigation indicates poor drainage conditions which should be investigated and corrected.

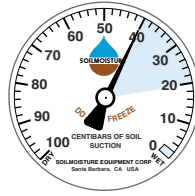

20-40 CENTIBARS:

Available moisture and aeration good for plant growth.

HEAVY CLAY SOILS: No irrigation required.

MEDIUM TEXTURED SOILS: No irrigation required.

SANDY SOILS: Irrigation started for coarser sandy soils in the 20-30 cb range. For finer sandy soils in the 30-40 cb range.

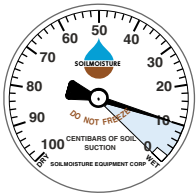

0-10 CENTIBARS:

Gauge readings in the range of 0-10cb indicated a surplus of water for plant growth. Water held by the soil in this range drains off within a few days. Persistent readings in this range indicate poor drainage conditions which should be corrected to obtain healthy plant growth.

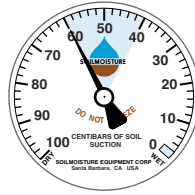

40-60 CENTIBARS:

Available moisture and aeration are good for plant growth in finer textured soils.

HEAVY CLAY SOILS: No irrigation required.

MEDIUM TEXTURED SOILS: Irrigation started in this range. The finer the texture the higher the reading before start of irrigation.

SANDY SOILS: Too dry. Hot windy conditions can force soil suction to high reading quickly and damage plants.

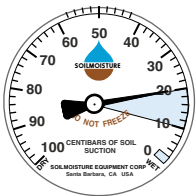

10-20 CENTIBARS:

Gauge readings in the range of 10-20cb indicate that there is ample moisture and also air in the soil for healthy plant growth in all types of soils. This range is often referred to as the “field capacity” range for soils, which means that the soil has reached its “capacity” and cannot hold anymore water for future plant growth. When soils are at “field capacity”, any additional water that is added drains out of the root zone within a day or two—before it can be used by the growing plant. If irrigation has been in process, it should be stopped when gauge drops to this level, since any further additional water will be quickly drained from the root zone and wasted, carrying with it valuable fertilizer.

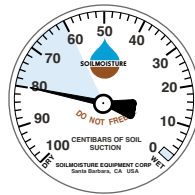

60-80 CENTIBARS :

Readily available moisture scarce, except in heavy clay soils.

HEAVY CLAY SOILS: Start of irrigation desirable as soil suction values reach 70-80 cb.

MEDIUM TEXTURED SOILS: Too dry. Hot, windy conditions can force soil suction to high reading quickly and damage plants.

SANDY SOILS: Too dry. Damage to plants will occur before irrigation can be applied.

ROUTINE MEASUREMENTS

The QuickDraw can be used for different types of measurements; for spot checks and measures from a permanent location:

a) Use for spot checks to determine the wetting area from drippers or to determine if there is enough moisture for germination in the seed-bed. Simply use the coring tool to shape the hole at the depth of measurement. Insert the QuickDraw and wait for the reading to become steady.

b) One can make routine measurements at a given depth in the same hole each time measurements are necessary. Use ½" PVC as a riser from the depth to measure to the soil surface. Place the pipe at the depth of measurement, minus an inch or so. Use an end cap or aluminum foil to prevent irrigation from a sprinkler from entering the pipe and wetting the soil at depth instead of from surface infiltration. Remove the cap and insert the QuickDraw and force the ceramic tip into the soil at the depth of measurement. Make your measurement as normal. Re-cap the riser pipe when finished.

Use the null knob to adjust the vacuum in the tensiometer to your set point for irrigation particular to the soil and crop being monitoring. The advantage of adjusting the null knob is to quickly determine if the set point has been reached or not and the question ... is it time to irrigate? Can be easily determined.

If the vacuum dial gauge exceeds the set point, then it is definitely time to schedule the irrigation. If the vacuum dial gauge decreases in vacuum, then the soil is more moist than your set point for irrigation and your decision is to not irrigate.

Using this approach, allows the user to rapidly make management decisions. Absolute, at equilibrium, measurements are not required using this approach.

TROUBLESHOOTING

Substantial change in the vacuum level

The successful operation of the Model 2900F Soilmoisture Probe is due to its structural rigidity and the fact that the air has been almost completely removed from the water and the internal structure of the Probe. For these reasons, any small amount of movement of water through the porous ceramic sensing tip will result in a substantial change of the vacuum level within the Probe. This very responsive action coupled with the use of the Null Knob, results in only a small disturbance to the water films in the surrounding soil, which are being measured. Hence, accurate measurements of soil suction can be made quickly.

Lack of response from gauge

If air is present in the unit, then a substantial amount of water must flow through the wall of the porous ceramic sensing tip to change the vacuum level within the Probe. The air within the Probe expands as the pressure is reduced (centibar reading increased), which causes a larger amount of water to move in and out of the surrounding soil. The result is a less responsive movement of the pointer on the dial gauge, a "spongy" action of the Null Knob, and a longer time to obtain an accurate soil moisture measurement. The response time is defined as the time required for the dial pointer to drop from 50 centibars to 10 centibars when the porous ceramic sensing tip is plunged into a container of water.

Over a period of many months or years, the pores in the ceramic sensing tip have a tendency to become clogged with deposits, which decreases the permeability of the ceramic. Such clogging will, of course, slow down the response time of the Probe. If the Probe has been carefully filled with water to remove all accumulated air, and the response time is still in excess of 2 seconds, it is advisable to replace the porous ceramic sensing tip with a new one.

50 centibars can not be reached

If, at any time, the operation of the Probe appears to be "spongy" and excessive time is required to make a soil suction reading, simply remove the Probe from the Carrying Case. Wipe the porous sensing tip with an absorbent tissue and turn the Null Knob so the pointer on the dial gauge registers 50 centibars. Then plunge the sensing tip of the Probe into a container of water and note the time required for the pointer to drop from 50 centibars to 10 centibars. If it is appreciably more than one second, it indicates that there is air accumulated within the Probe. To remove the air from the Probe and restore the fast response time, refill the Probe with water as described under "Initial Filling", page 2.

If the porous ceramic sensing tip has been cracked during use, it will permit air to enter the system. A very fine crack not be readily observed. Usually under these circumstances, it is not possible to obtain a reading of 50 centibars to conduct the response time test. If a dial reading of 50 centibars cannot be reached by drying the sensing tip and turning the Null Knob, there is too much air in the system, and there may also be a crack in the sensing tip. To replace the porous ceramic sensing tip, see the section on this.

Replacing the Porous Ceramic Sensing Tip

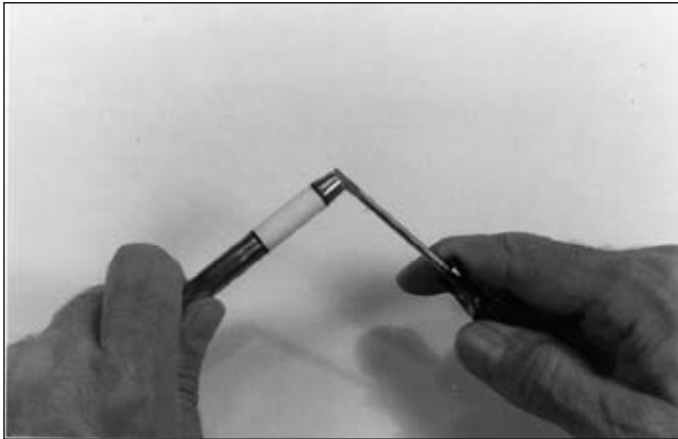

(Figure 22)

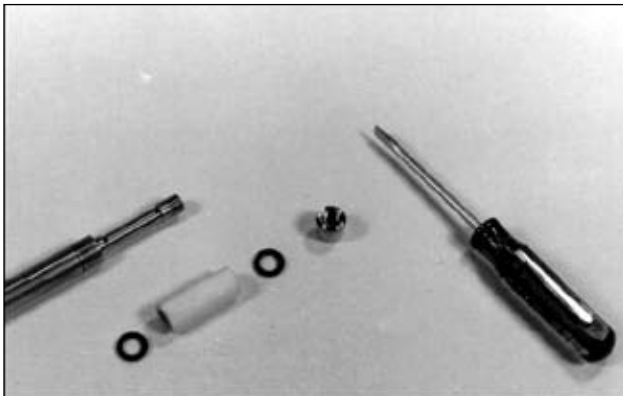

(Figure 23)

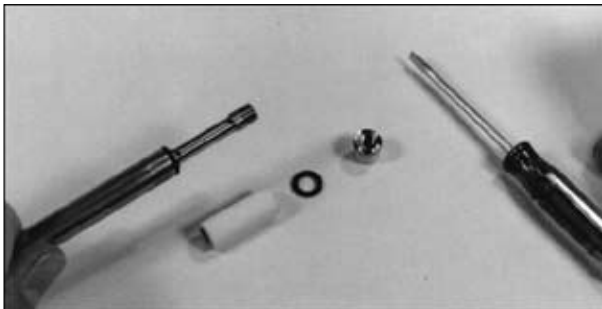

(Figure 24)

If the porous ceramic sensing tip has been broken or cracked during use or if the pores of the ceramic have become clogged resulting in too long Probe response time, it can be readily replaced with a new one. The "O" ring seals must also be replaced when you replace the ceramic sensing tip,.

To replace the sensing tip, first remove the slotted cap nut at the end of the Probe. Use a large screw-driver that fits the slot in the cap nut, or the small pointer-adjusting screwdriver can be used, by inserting the side of the screwdriver in the slot in the nut, as shown in Fig. 22.

When facing the end of the Probe, turn the cap nut COUNTERCLOCKWISE to loosen it. Completely remove the cap nut, the porous ceramic sensing tip, and the two "O" ring seals at either end of the sensing tip. When you re-move the parts, be sure that the smooth surfaces on the cap nut and on the stem of the Probe, where the "O" rings seat, are not scratched or marred. It is essential that these surfaces are kept smooth to assure a complete vacuum seal when the new sensing tip is installed. Clean off any accumulated corrosion from the stem of the Probe.

Fig. 23 shows the stem of the Probe with the two small cross holes. The "O" ring seals, porous ceramic sensing tip and slotted cap nut are arranged in this photo in the same manner as they fit on to the stem of the Probe.

Figs. 24 through 28 show the successive operations in mounting the parts on the stem of the Probe.

In the final assembly operation, screw on the slot-ted cap nut and tighten it securely with a screw-driver. The slotted cap screw should be tightened as far as it will go. Parts have been carefully machined so the "O" ring seals are properly squeezed when the slotted cap nut is screwed completely on until it seats on the end of the Probe stem. The "O" rings make a vacuum-tight seal between the brass surfaces of the Probe stem parts and the ends of the porous ceramic sensing tip.

The ends of the porous ceramic sensing tip have been machined smooth to assure a vacuum-tight seal. When you mount the porous ceramic sensing

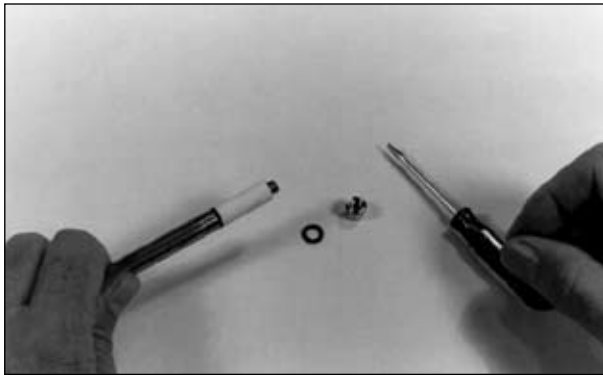

(Figure 25)

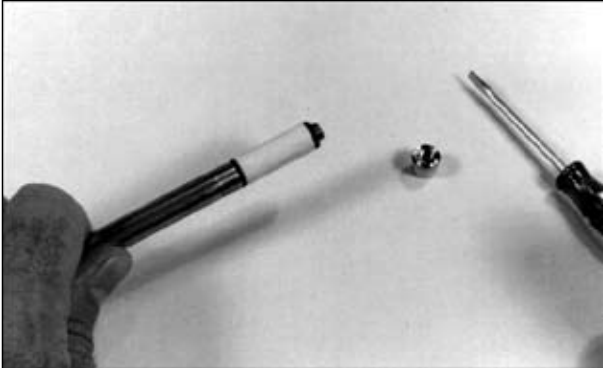

(Figure 26)

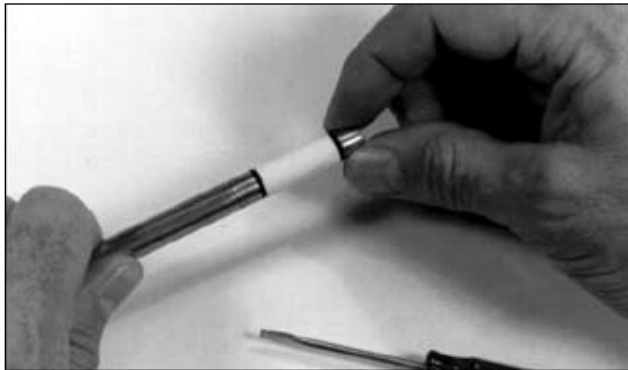

(Figure 27)



(Figure 28)

tip on the Probe, make sure that the sensing tip is not scratched or chipped.

The Porous Ceramic Sensing Tip is supplied with a tapered configuration. The taper matches the taper of the Coring Tool. The taper assures better contact with the soil, which increases sensitivity and speed of response.

When you replace the tip, special care must be taken to see that the "top" arrow marked on the tip points in the direction as shown in Fig. 29.

After replacing the tip, fill the Probe as described in "Initial Filling".

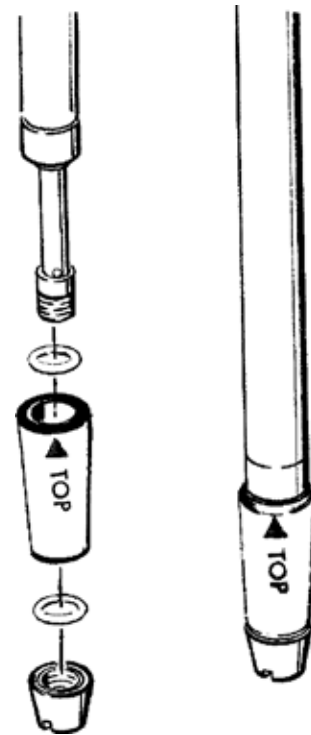

(Figure 29)

Replacing The Dial Gauge

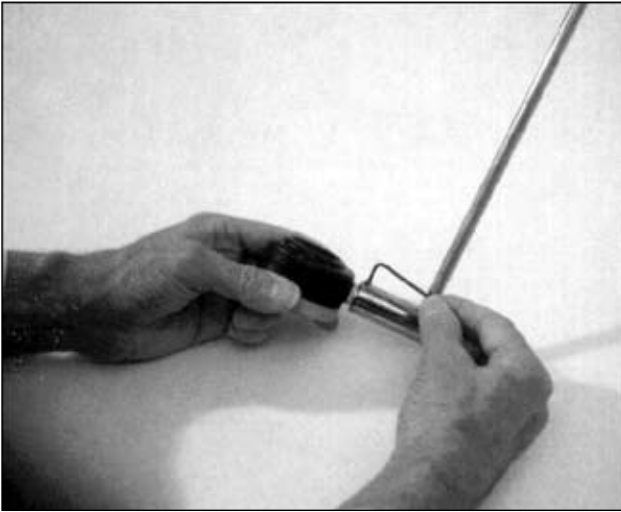

(Figure 30)

If the dial gauge has been mechanically damaged making it inoperative, it may be replaced in the field.

First remove the socket head set screw from the handle, as shown in Fig. 30. This is an "Allen" head set screw that accepts a 3/32" size Allen wrench, which is supplied in the Accessory Kit.

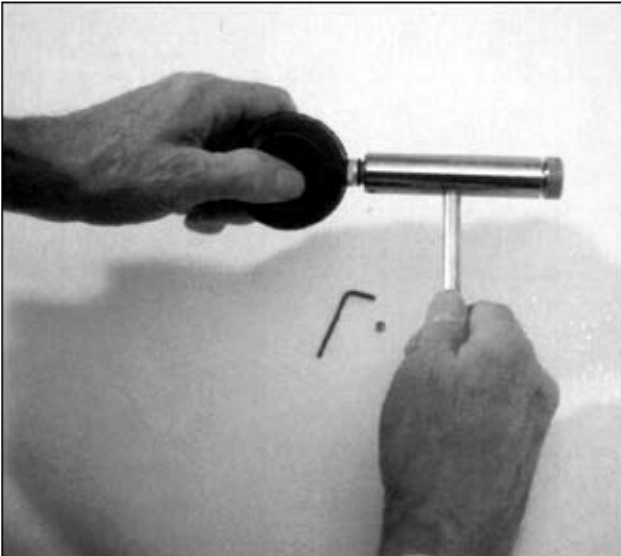

(Figure 31)

Then grasp the dial gauge firmly, as shown in Fig. 31, and turn it counterclockwise until it is free from the handle.



(Figure 32)

Fig. 32 shows the dial gauge removed from the handle. The internal connecting tube usually remains in the dial gauge. Carefully pull out the internal connecting tube from the dial gauge.

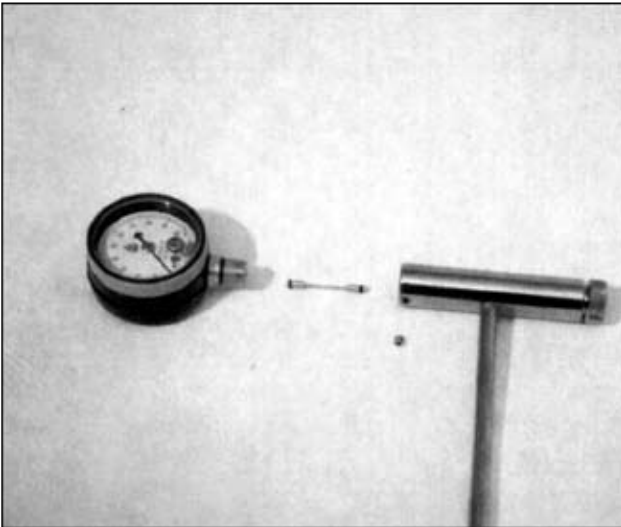

(Figure 33)

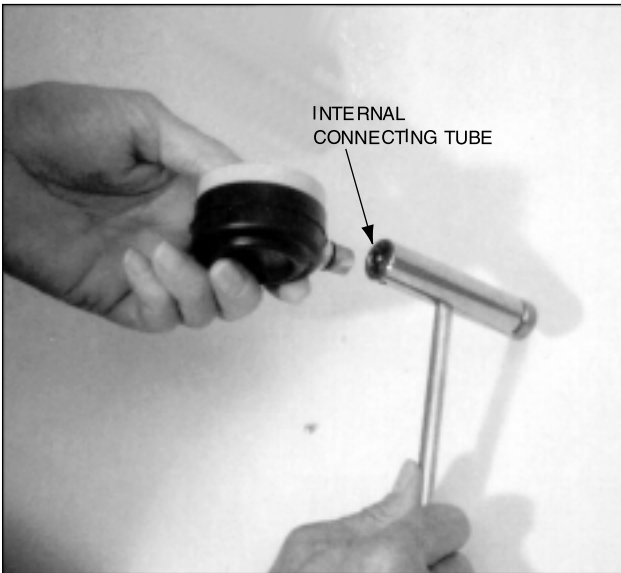

(Figure 34)

Fig. 33 shows an “exploded” view of the various parts.

The internal connecting tube has “O” ring seals at each end. Push the internal connecting tube all the way into the recess in the handle of the Probe, as shown in Fig. 34. Then screw the new replacement dial gauge into the handle, also illustrated in Fig. 34. Make sure that the internal connecting tube enters the hole in the stem of the dial gauge. If the “O” ring seals on the ends of the internal connecting tube seem to resist entering the Probe handle and dial gauge stem, apply a thin layer of Vaseline or vacuum grease on the “O” ring seals to reduce the friction. After screwing the replacement dial gauge completely into the Probe handle and orienting it at the proper angle, replace the Allen head set screw and wrench it down to hold the dial gauge firmly in place.

After replacing the dial gauge, the Probe must be re-filled with water as described in “Initial Filling”.

Replacement dial gauges supplied by the factory have been filled under high vacuum with a mixture of ethylene glycol and water. This procedure protects the gauge from freezing damage when in use and also makes it easy to remove the air from the Probe during the filling operation. If the replacement dial gauge has lost some of the filling fluid through mishandling, it can still be used. However, it will require a number of Probe filling cycles to remove all the air from the gauge before the desired response time is obtained.

TIME REQUIRED TO MAKE A READING

The time that it takes to make a soil suction reading varies with soil types and amount of moisture. In order to make a soil suction reading, a small amount of water must be transferred between the soil and the sensing tip of the Probe.

Although this transfer is reduced to a minimum by the use of the Null Knob, the water that is transferred must move through the soil itself. The rate at which this water moves through the soil is determined by the "capillary conductivity" of the soil. The capillary conductivity not only varies from soil to soil, but also with the soil suction value for any given soil. In moist soils, the capillary conductivity is higher, and in dry soils the capillary conductivity is lower.

Since capillary conductivity drops off rapidly as soil suction values increase, it requires a longer time to make a soil suction reading in dry, as compared to moist soil. The type of soil will also influence the time required to make a reading.

To illustrate the effect of varying capillary conductivity, Fig. 35 shows the time required for the Probe to recover to a reading of 15 centibars in a sandy-loam soil when soil suction value in the Probe is arbitrarily reduced to 5 centibars of soil suction. The experiment is repeated with the soil suction value in the Probe increased to 25 centibars of soil suction. Under these conditions, you will note that the recovery time is approximately 1 to 2 minutes.

Fig. 35 shows the same experiment in the same soil when the equilibrium soil suction value was 37 centibars. Here, you will note that the recovery time is approximately 5 minutes in each case. The experiment is again repeated in the same soil when the soil suction value is approximately 48 centibars. Fig. 38 shows this graph, and you will note that in this case, the recovery time is approximately 8 to 9 minutes.

These experiments demonstrate the change in rate at which moisture moves along the water films in the soil as soil suction values change and convey a feeling for the response of the Probe to adjustments of the Null Knob when making a reading.

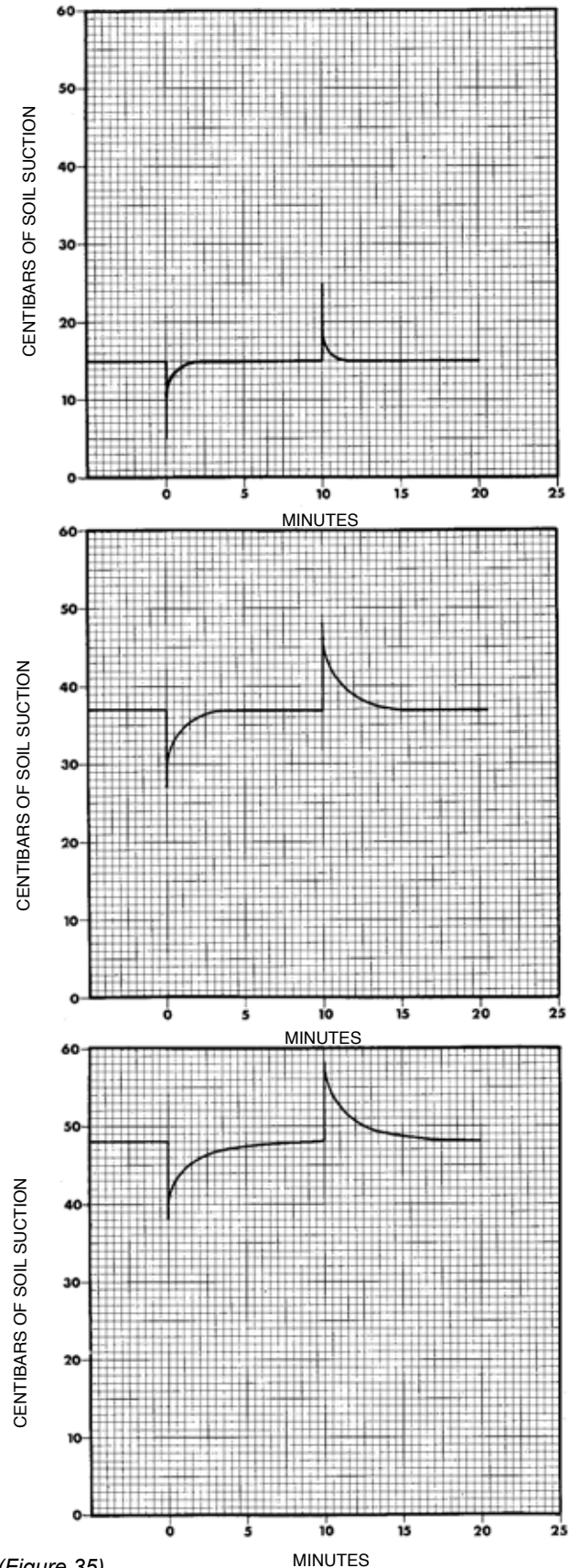

(Figure 35)

Approximate soil moisture/tension values for the "knee-of-the-curve", and Managed Allowable Depletion for 12 Soil Textural Classifications.

Prepared by: Richard White, Technical Applications, Soilmoisture Equipment Corp., August 200· 805-964-3525 x 248

Approximate range of values for each soil textural classification

| Soil Texture Classification | Bulk Density g/cm ³ | Field Capacity cbar=kPa | "Knee of Curve" cbar=kPa | 50% in/ft | MAD* cm ³ /cm ³ | Available in/ft | Water cm ³ /cm ³ | Field in/ft | Capacity cm ³ /cm ³ | Wilting in/ft | Percent cm ³ /cm ³ |
|-----------------------------|-----------------------------------|----------------------------|-----------------------------|--------------|--|--------------------|---|----------------|--|------------------|---|
| | | | | | | | | | | | |
| Sand | 1.66 | 9 | 20 | 1.14 | 0.04 | 0.84 | 0.07 | 1.56 | 0.13 | 0.72 | 0.06 |
| | 1.68 | 10 | 25 | 1.32 | 0.04 | 0.96 | 0.08 | 1.80 | 0.15 | 0.84 | 0.07 |
| Loamy Sand | 1.61 | 10 | 25 | 1.44 | 0.04 | 0.95 | 0.08 | 1.91 | 0.16 | 0.96 | 0.08 |
| | 1.61 | 11 | 30 | 1.50 | 0.05 | 1.08 | 0.09 | 2.04 | 0.17 | 0.96 | 0.08 |
| Sandy Loam | 1.53 | 10 | 22 | 1.61 | 0.05 | 1.06 | 0.09 | 2.14 | 0.18 | 1.08 | 0.09 |
| | 1.57 | 11 | 27 | 1.85 | 0.07 | 1.54 | 0.13 | 2.62 | 0.22 | 1.08 | 0.09 |
| Silt Loam | 1.37 | 11 | 27 | 2.24 | 0.08 | 1.84 | 0.15 | 3.16 | 0.26 | 1.32 | 0.11 |
| | 1.44 | 12 | 32 | 2.47 | 0.10 | 2.30 | 0.19 | 3.62 | 0.30 | 1.32 | 0.11 |
| Silt | 1.43 | 11 | 25 | 2.39 | 0.10 | 2.38 | 0.20 | 3.58 | 0.30 | 1.20 | 0.10 |
| | 1.43 | 12 | 30 | 2.41 | 0.10 | 2.42 | 0.20 | 3.62 | 0.30 | 1.20 | 0.10 |
| Loam | 1.41 | 12 | 30 | 2.06 | 0.06 | 1.47 | 0.12 | 2.79 | 0.23 | 1.32 | 0.11 |
| | 1.46 | 13 | 35 | 2.33 | 0.08 | 1.77 | 0.15 | 3.21 | 0.27 | 1.44 | 0.12 |
| Sandy Clay | 1.30 | 13 | 35 | 3.27 | 0.04 | 1.02 | 0.08 | 3.78 | 0.31 | 2.76 | 0.23 |
| | 1.33 | 14 | 40 | 3.51 | 0.06 | 1.25 | 0.11 | 4.13 | 0.35 | 2.88 | 0.24 |
| Sandy Clay Loam | 1.37 | 13 | 40 | 2.39 | 0.04 | 0.93 | 0.08 | 2.85 | 0.24 | 1.92 | 0.16 |
| | 1.43 | 14 | 45 | 2.63 | 0.06 | 1.42 | 0.12 | 3.34 | 0.28 | 1.92 | 0.16 |
| Clay Loam | 1.29 | 14 | 45 | 2.99 | 0.06 | 1.41 | 0.12 | 3.69 | 0.31 | 2.28 | 0.19 |
| | 1.33 | 15 | 50 | 3.24 | 0.08 | 1.92 | 0.16 | 4.20 | 0.35 | 2.28 | 0.19 |
| Silty Clay Loam | 1.26 | 13 | 40 | 3.27 | 0.08 | 1.97 | 0.16 | 4.25 | 0.35 | 2.28 | 0.19 |
| | 1.29 | 14 | 50 | 3.34 | 0.09 | 2.12 | 0.18 | 4.40 | 0.37 | 2.28 | 0.19 |
| Silty Clay | 1.21 | 12 | 38 | 4.19 | 0.08 | 1.89 | 0.16 | 5.13 | 0.43 | 3.24 | 0.27 |
| | 1.23 | 14 | 42 | 4.34 | 0.08 | 1.96 | 0.16 | 5.32 | 0.44 | 3.36 | 0.28 |
| Clay | 1.21 | 14 | 55 | 3.86 | 0.05 | 1.23 | 0.10 | 4.47 | 0.37 | 3.24 | 0.27 |
| | 1.28 | 15 | 60 | 4.52 | 0.08 | 1.83 | 0.15 | 5.43 | 0.45 | 3.60 | 0.30 |

Source: Watright ~ Center for Irrigation Technology, Cal State Univ. Fresno, www.watright.org

* MAD = managed allowed depletion

** "Knee of the curve" = the change in the soil moisture-tension relationship, where water content or water tension dominates the relationship.



TIPS FOR SCHEDULING IRRIGATIONS

Tips for Scheduling Irrigations based upon managed, allowed depletion for 12 soil textural classifications:

The table on the next page (Fig. 36), has been developed from data presented by Waterright at the Center for Irrigation Technology, Fresno State University. Each soil textural classification affects the way water is held and released to the crop. Typically one has applied the 50% MAD rule, where soil available water does not deplete further than the 50% managed allowed depletion limit. This insures that the crop is under no water stress and maximum growth and yield is possible. The 50% limit can be related to the “knee-of-the-moisture/tension-curve” where water at lower tensions impart no stress, while at greater tensions the crop experiences mild and then moderate to severe water stress. Use the following guide to help your irrigation management decisions.

Care and Maintenance

The QuickDraw is a little more difficult to service the first time. For this reason, we recommend that the unit be kept serviced well at all times.

The soil environment is hard on farm tools. Keep the QuickDraw clean between uses. Use a small wash bottle or even a drinking water bottle works very well. Never put the QuickDraw away dirty. Simply wash the ceramic tip in water to remove soil and salty soil solutions. Keep the sponge in the carrying case clean at all times, by rinsing it once per week.

At the end of each day, take a few moments to flush out the interior of the tensiometer to remove salts in solution that may have entered the tensiometer water column in routine measurements, by using this procedure:

- a) Clean the ceramic tip as discussed above,
- b) Submerge the ceramic tip in water and use the “null” knob (see operating instructions) to draw excess clean water into the tensiometer.
- c) Dial the knob counter-clockwise (the vacuum gauge should initially register 30 to 50 cbar and drop to 0 cbar as water is drawn into the tensiometer. The excess water will accumulate in the head space behind the null knob. Repeat the procedure several times to insure that you have loaded the tensiometer with clean water.
- d) Remove the tensiometer tip from the water and reverse the flushing process, by dialing the null knob clockwise. The null knob piston will force excess water from the tensiometer through the ceramic tip. Be very careful to NOT OVER PRESSURIZE THE TENSIO METER. This may cause slight damage to the dial gauge or may alter the zero set point. When dialing the null knob in the clockwise direction the needle on the gauge will go positive and will lay against a pin on the face of the dial gauge just to the left of the zero marker on the gauge. Use small adjustments to the null knob to force the excess water out of the unit and wait for the dial to return to zero between adjustments to avoid damage.
- e) Repeat the process until all the excess water has been removed.
- f) The QuickDraw should perform as normal.

At the end of the growing season, most QuickDraw users simply put the unit on the shelf in warm location as instructed. The QuickDraw Tensiometer is a water column based instrument and is susceptible to freezing. The following spring they go to use the instrument and it doesn't work. WHY?

- a) Typically the instrument has not been cleaned as described above,
- b) When placed on the shelf, has the sponge been wetted?
- c) Sitting on the shelf in a warm location will dry out the sponge over the off-season months, and will therefore draw water out of the tensiometer. This may cause the unit to cavitate and loose hydraulic contact between the ceramic tip and the interior water column. The unit will not work as before, until it has been reserviced.

To avoid this situation follow these simple tips:

- a) Clean the QuickDraw tensiometer as described above,
- b) Keep the sponge wet,
- c) At the end of the season, take a little time to wrap the ceramic tip in "Saran-Wrap" (this product works the best as a vapor barrier),
- d) Replace the QuickDraw with the ceramic tip wrapped in Saran Wrap into the carrying case,
- e) Place the unit in a non-freezing location.
- f) Next spring, un-wrap the saran and re-wet the sponge. The unit should be in top working order.

Potted Plants



The Model 2900F Soilmoisture Probe is particularly valuable in determining moisture conditions in potted plants such as those in commercial buildings or nurseries. The Probe responds quickly in planting mixes used in potted plants and usually can be pushed directly down into the root zone without coring a hole. Its portability eliminates vandalism, which is not true of fixed moisture measuring instruments. With the Model 2900F, a thoughtful plan can be developed to keep maintenance and water costs to a minimum.

(Figure 37)

Using a number of Probes at the Same time.

For frequent evaluation of moisture conditions in large irrigated fields, the use of several Probes can speed up the work. As an example, an agricultural consultant who programs irrigation for his client can insert a number of Probes in a field without taking immediate readings. When the crop is high, the Probes would be flagged with a red cloth on a wire stake so they can be easily found. The consultant can then make his other crop observations. After completing his other work, he would return to pick up the Soilmoisture Probes. By this time, the Probes would have reached equilibrium, and the readings would be quickly noted.

| | ITEM PART # | DESCRIPTION |
|-----|--------------------|----------------------------|
| 1. | Z2901-001 | PROBE CAP |
| 2. | M805X008PKG05 | "O" RING SEAL |
| 3. | Z2901-002SK | REPLACEMENT SENSING TIP |
| 4. | Z060FG3 | VACUUM DIAL GAUGE |
| 5. | Z2901F-300 | GAUGE CAPILLARY ASSY. |
| 6. | M805X003PKG05 | "O" RING SEAL (2 REQ'D) 14 |
| 6a. | M802X003-1K1 | PRESSURE RELIEF "O" RING |
| 7. | Q1032CAE03PK41 | SET SCREW, 10-32 x 3/16" |
| 8. | M802X103PKG05 | "O" RING SEAL |
| 9. | M803X014PKG05 | "O" RING SEAL |
| 10. | Z2901F-001 | NULL ADJUSTING KNOB |
| 11. | 2901FL12 | PROBE ASSEMBLY, 12" |
| | 2901FL18 | PROBE ASSEMBLY, 18" |
| | 2901FL24 | PROBE ASSEMBLY, 24" |
| 12. | 2903FL12 | CARRYING CASE, 12" |
| | 2903FL18 | CARRYING CASE, 18" |
| | 2903FL24 | CARRYING CASE, 24" |
| 13. | Z2903F-100 | SPONGE ASSEMBLY |
| 14. | Z2903F-001 | SHEATH TOP CAP |
| 15. | Z2903F-002 | SHEATH END CAP |
| 16. | 2900FK1 | ACCESSORY KIT |
| 17. | Z2902L12 | CORING TOOL, 12" |
| | Z2902L18 | CORING TOOL, 18" |
| | Z2902L24 | CORING TOOL, 24" |
| 18. | Z2953F | CLEANING ROD |
| | | |
| | | |

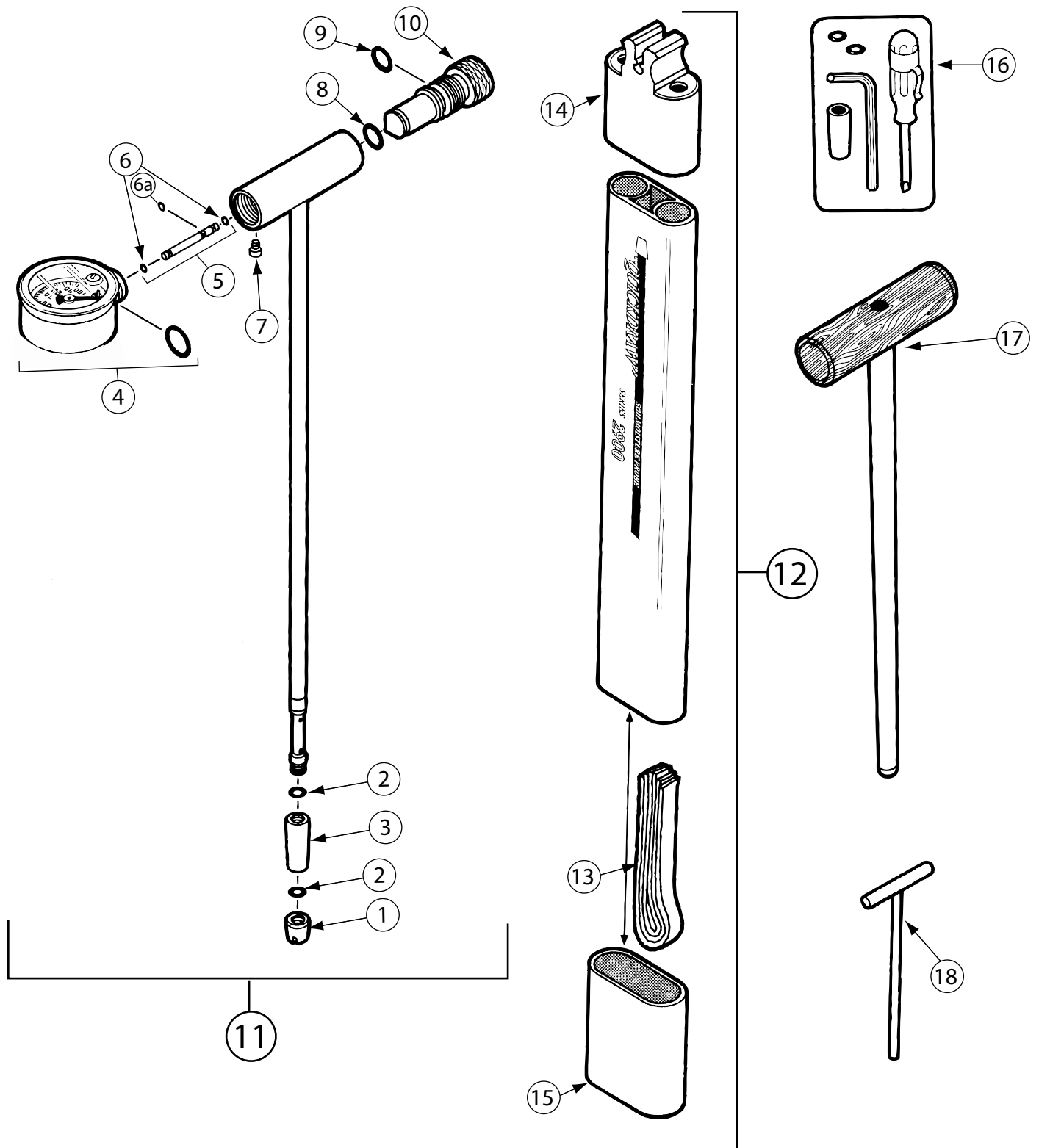

**With dealers throughout the world,
you have convenience of purchase and assurance
of after-sales service.**

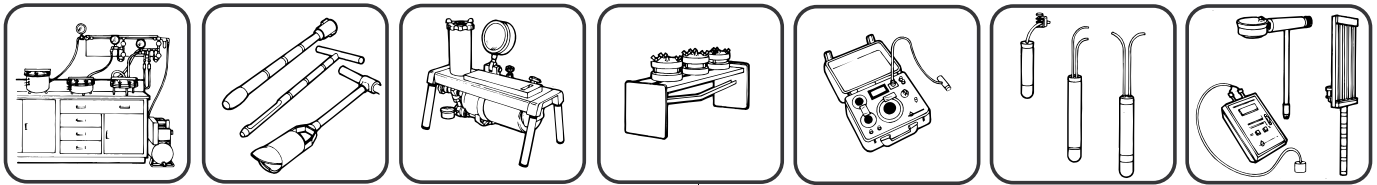

© COPYRIGHT 2009 ALL RIGHTS RESERVED 0898-2900F1