

S5HD

D-TILTMETER

DIGITAL TILTMETER

INCLINOMETERS
& PENDULUMS



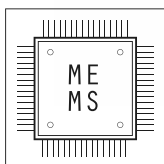

D-TILTMETER DIGITAL TILTMETER

The measurement of inclinations is essential for the control and security of structures in elevation, both during the construction phase and in operation.

Thanks to the enclosure design and the MEMS technology, D-Tiltmeters ensure high accuracy and very low dependence on thermal factors.

D-Tiltmeters can be read locally using a portable readout, or centralized with OMNIAlog datalogger for remote monitoring and alerting.

MAIN APPLICATIONS

- SHM (Structural Health Monitoring)
- Building safety along adjacent excavations
- Diaphragms and retaining walls
- Historical buildings
- Decks and bridge piers

FEATURES

- Available in uniaxial and biaxial versions
- IP67 class protection
- High performances
- Minimal temperature dependency
- Waterproof connector



Meet the essential requirements of the EMC Directive 2014/30/UE

TECHNICAL SPECIFICATIONS

PRODUCT CODES	0S541HD0202 (uniaxial) 0S542HD0202 (biaxial)	0S541HD0502 (uniaxial) 0S542HD0502 (biaxial)	0S541HD1002 (uniaxial) 0S542HD1002 (biaxial)
Measurement principle	self-compensated MEMS inclinometer	self-compensated MEMS inclinometer	self-compensated MEMS inclinometer
Measuring range ⁽¹⁾	±2.5°	±5°	±10°
Repeatability (reading frequency 2 Hz)	<0.0013°	<0.0013°	<0.0013°
Resolution (reading frequency 2 Hz)	0.00056°	0.00056°	0.00056°
Sensor mechanical bandwidth	18 Hz	18 Hz	18 Hz
Stability @ 24 hours	<0.003°	<0.003°	<0.003°
Stability @ 30 days ⁽²⁾	<0.007°	<0.007°	<0.007°
Sensitivity ⁽³⁾	see Calibration Report	see Calibration Report	see Calibration Report
Accuracy:			
Pol. MPE ⁽⁴⁾	±0.002°	±0.002°	±0.002°
Lin. MPE ⁽⁴⁾	±0.004°	±0.004°	±0.004°
Offset temperature dependency		±0.002° / °C	
Power supply		from 8 to 28 Vdc	
Signal output and protocol		RS485, Modbus RTU ⁽⁵⁾	
A/D converter		32 bit, precision 38-kSPS	
Average consumption		Uniaxial sensor: 4.3 mA @ 24 Vdc, 8.0 mA @ 12 Vdc Biaxial sensor: 5.3 mA @ 24 Vdc, 10.0 mA @ 12 Vdc	
Temperature operating range		from -30°C to +70°C	
Internal temperature sensor:		Embedded on electronic board	
- measuring range		- 40°C to +125°C	
- accuracy (resolution)		±1°C with temperature range -10°C to +85°C (res. 0.01 °C)	
Internal humidity sensor: ⁽⁶⁾		Embedded on electronic board	
- measuring range		0 to 100% RH	
- accuracy (resolution)		±5% RH with humidity range 0 to 95% RH (res. 0.025% RH)	
On-board supply voltage monitor: ⁽⁶⁾		Embedded on electronic board	
- measuring range		0 to 36 V	
- accuracy (resolution)		±5% FS (res. 0.01 V)	
Signal cable		0WE106IP0ZH	
Cabling		M12 male connector on sensor body, 3-port T-shaped splitter for cable wiring	
Max. cable length to logger		1000 m (for more information see FAQ #073) ⁽⁷⁾	

(1) Other ranges available on request

(2) Measured stability after 30 days, reference reading taken 24 hours after installation. Test performed under nearly-repeatability conditions.

(3) Sensitivity is a specific parameter different for every gauge. The sensitivity is calculated during gauge calibration test and inserted into the Calibration Report.

(4) MPE is the Maximum Permitted Error on the measuring range (FSR). In the Calibration Report, the accuracies of the gauge are calculated using both linear regression (\leq Lin. MPE) and polynomial correction (\leq Pol. MPE)

(5) RS485 not-optoisolated Modbus communication with RTU Protocol. Default output is sen alpha, other units available are degree, mm/m or inch/feet (to be requested at order). Sisgeo Modbus protocol manual is available for download here: <https://www.sisgeo.com/downloads-en/manuals/category/software-and-apps-3.html>

(6) These sensors are installed on the internal electronic board to give information in the event of probe malfunction.

(7) Refer to FAQ section on Sisgeo website: www.sisgeo.com/faq

PHYSICAL FEATURES

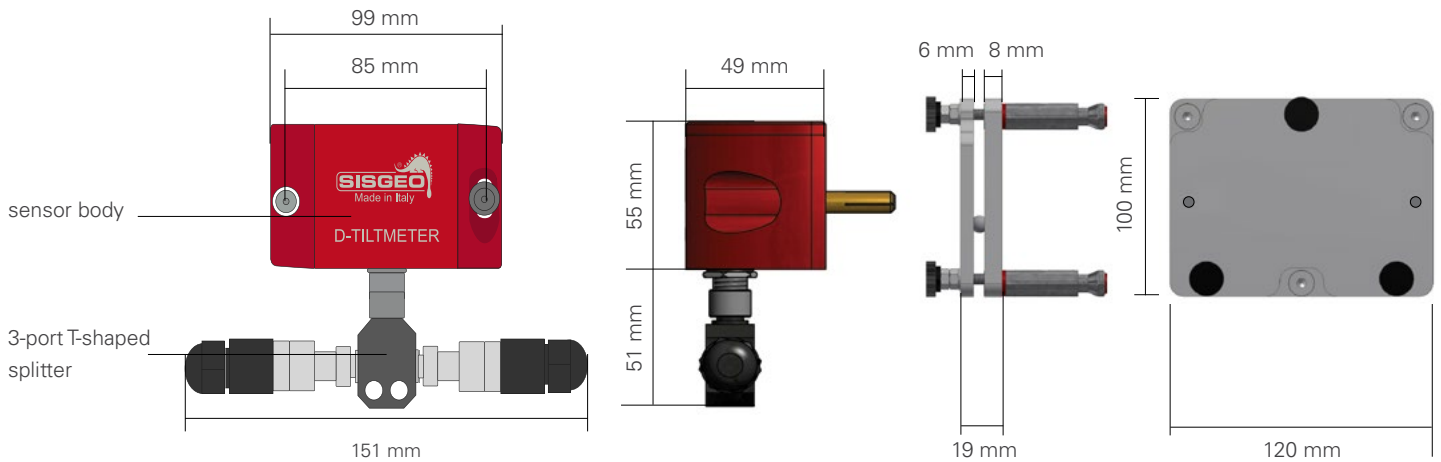

DIMENSIONS AND MATERIALS

	TILTMETER	ADJUSTMENT PLATE OS540AP3D02
Sensor body dimensions (LxHxW)	99 x 55 x 49 mm	-
Fixing support	N.2 fischer anchor bolts model PO M6	N.3 fischer anchor bolts model SL M6
Overall dimensions (LxHxW)	151 x 106 x 49 mm (including connectors)	100 x 120 x 61 mm
Material	anodized aluminum	stainless steel
IP class	IP67	-

ACCESSORIES AND SPARE PARTS

ADJUSTMENT PLATE OS540AP3D02

Fine adjustment plate for S540HD tilt meters, especially recommended for the small ranges ($\pm 2.5^\circ$ and $\pm 5^\circ$). Working on three knobs, you can set the tilt meter at mid scale or other desired position.

RESISTANCE ENDING DEVICE OETERMRESIO

Termination resistance with connector, needed to close every digital instrument chain. The value of resistor depends on the layout of each monitoring system. For more detail see the [FAQ#076](#).

DIGITAL JUNCTION BOX OEPD023IPID

Junction box for chains of digital instruments, composed by IP67 plastic box, internal electronic board for wiring and three cable glands.

MEASURING BOX OEPM010IPIO

Measuring box for manual reading of digital gauges, composed by IP67 plastic box with electric board for cable wiring, cable gland and female panel connector.

RESISTANCES KIT (SPARE) OERESIKIT00

Kit composed by one 120 Ohm, two 240 Ohm, three 360 Ohm and four 480 Ohm resistance ending devices. Each one has an M12 5-pin connector for linking to SISGEO digital gauges. Check compatibility with old digital gauges with your Sales Representative.

AUTOMATIC READINGS

D-Tiltmeters can be connected in different chains following the project needs; digital instrument chains can be jointed in only one cable using the 0EPD023IPD0 junction box. One chain of digital instruments can be composed by D-Tiltmeters and any other kind of Sisgeo digital instruments (tiltmeters, tilt beams, in-place inclinometers, H-Levels, etc...). Instrument chain(s) are connected to OMNIAlog datalogger that will be able to manage until 250 digital instruments.

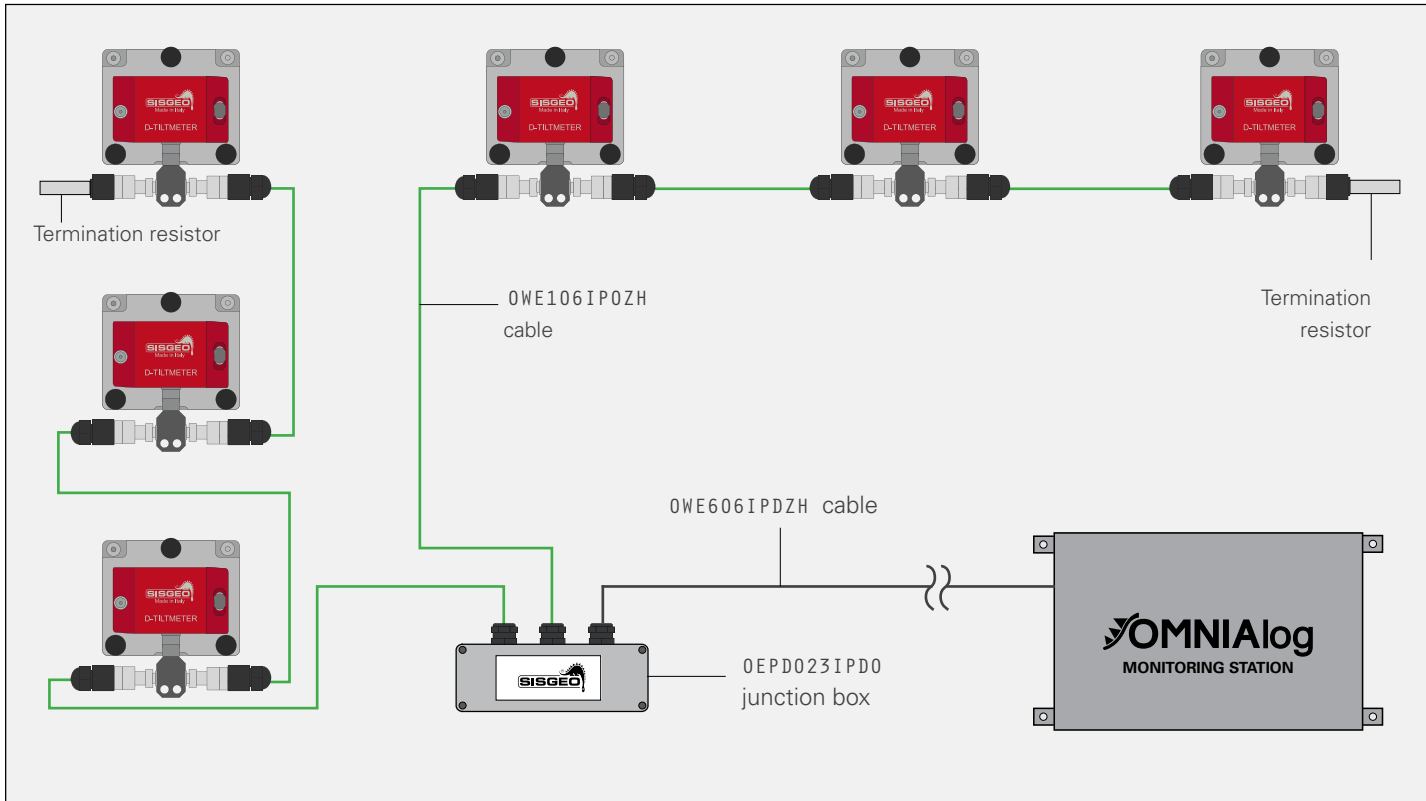

MANUAL READINGS

If installed in a place that do not permits direct connection with portable readout, the D-Tiltmeter chain need to be connected to the 0EPM010IPI0 measuring box with standard 0WE106IP0ZH signal cable. To take readings, the technician have only to connect New Leonardo to the measuring box and push a button: the readout will store the data of all instrument of the chain.

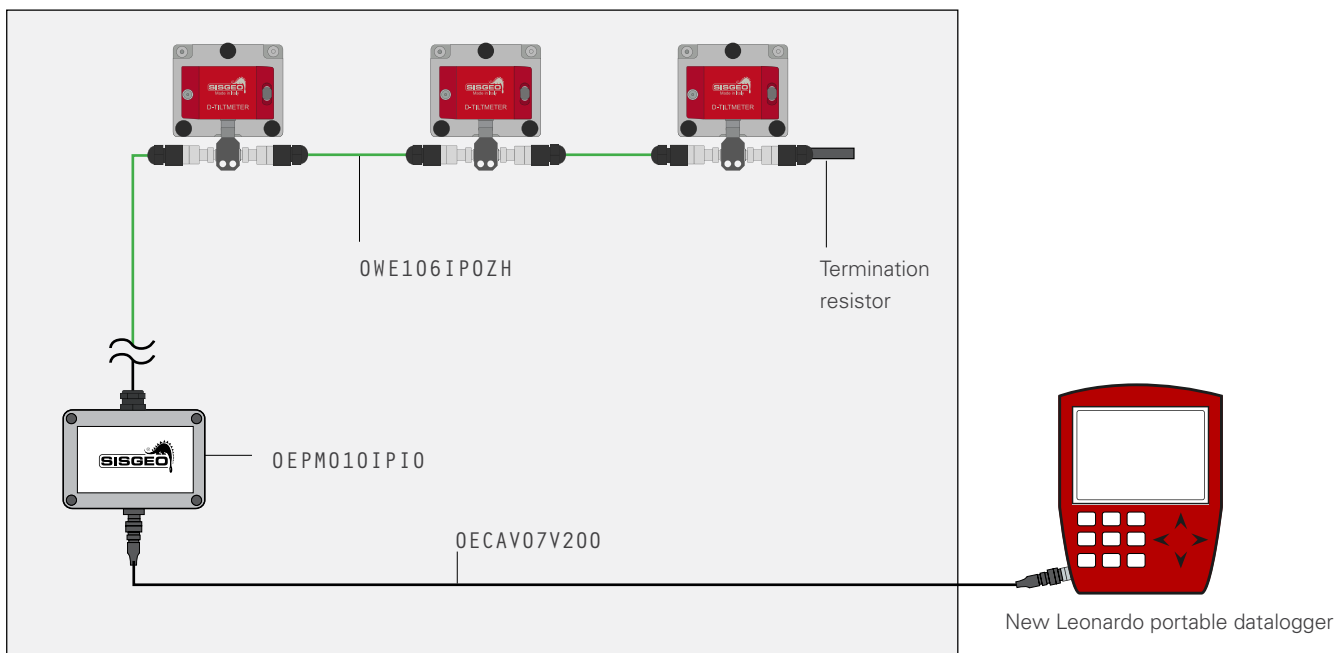

EXAMPLE OF INSTALLATION ON CABLE-STAYED BRIDGE

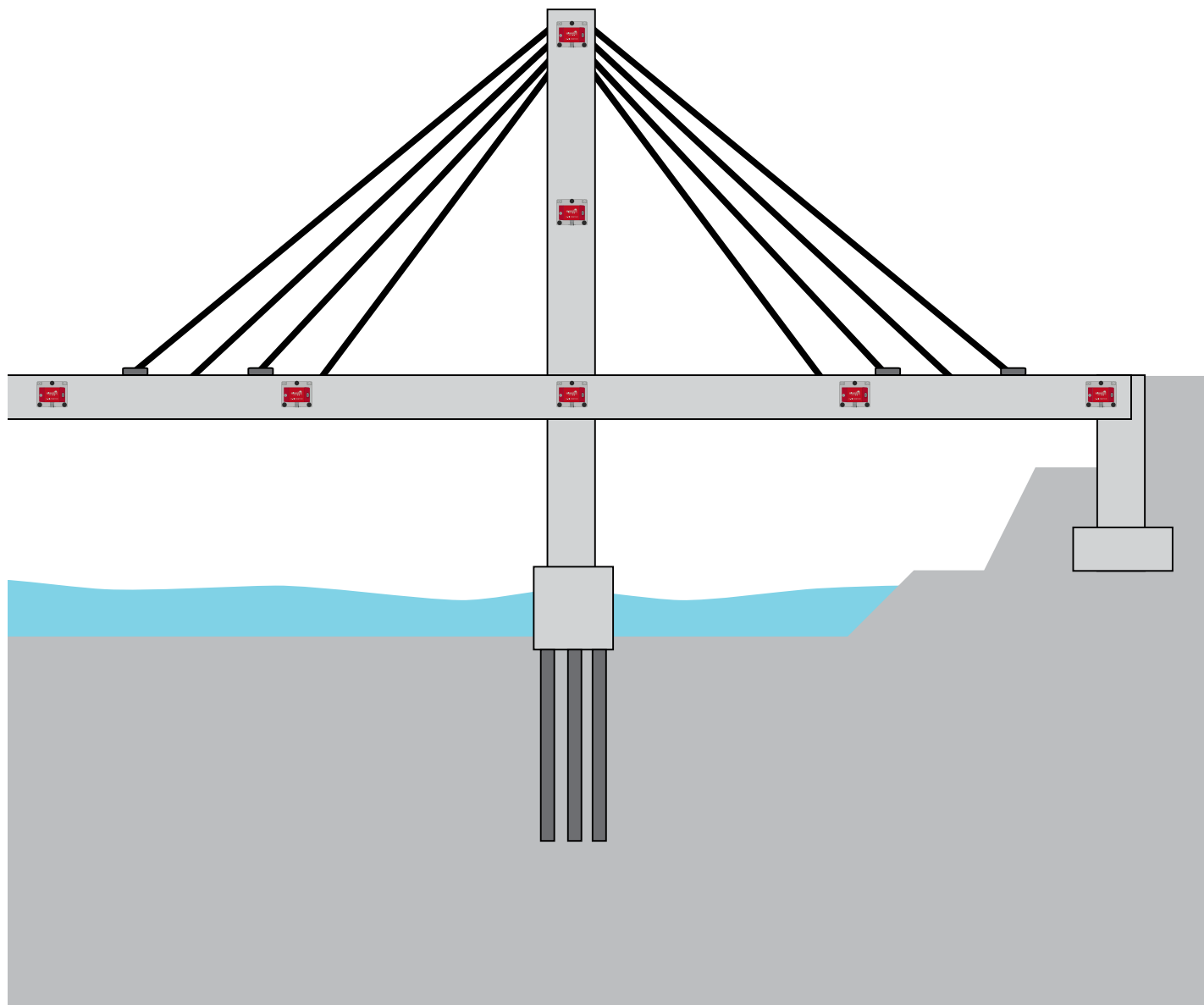

READABLE BY

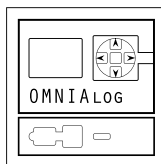
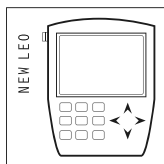

All the information in this document is the property of Sisgeo S.r.l. and should not be used without permission from Sisgeo S.r.l. We reserve the right to change our products without prior notice. The datasheet is issued in English and other languages. In order to avoid discrepancies and disagreement on the interpretation of the meanings, Sisgeo Srl declares that English Language prevails.

SISGEO S.R.L.

VIA F. SERPERO 4/F1
20060 MASATE (MI) ITALY
PHONE +39 02 95764130
FAX +39 02 95762011
INFO@SISGEO.COM

ADDITIONAL SUPPORT

SISGEO offers on-line assistance service to the Customers in order to maximize the performance of the system and training on the correct use of the instrument/readout.

For more information contact mail: assistance@sisgeo.com